

Easy One Touch 5

Dash & Windshield Mount • Support pour tableau de bord et pare-brise
• Supporto telefono per parabrezza e cruscotto • Armaturen Brett und
Windschutzscheibenhalterung • Montaje de tablero y parabrisas

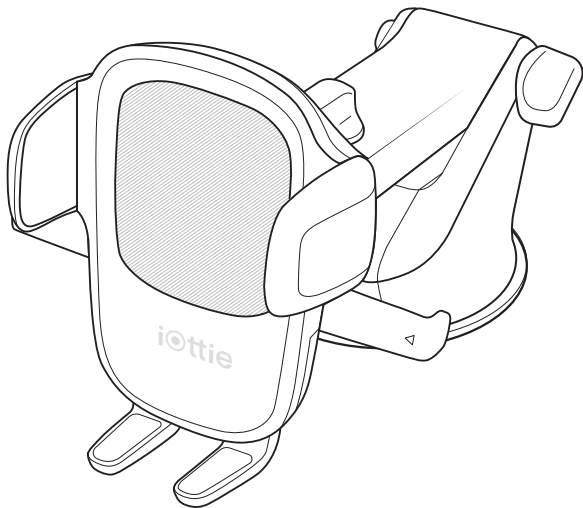

Manual • Guide • Manuale • Handbuch • Manual



iottie

Getting Started

For optimal mounting, please follow the detailed instructions within this manual when using the Easy One Touch 5. iOttie is not liable for possible damages due to product misuse.

Critical Information

- The Dashboard Pad is mounted with a semi-permanent adhesive tape. Each pad is one-time use only. Once removed, it cannot be re-mounted.
- When mounting, it is recommended that the surface & product be above 40° F.

Specifications

ITEM	SPECIFICATIONS
DEPTH	6.5"
WIDTH	4.2"
HEIGHT	4"
WEIGHT	7.2 oz

! Telescopic Arm extends from 5 inches to 8 inches.

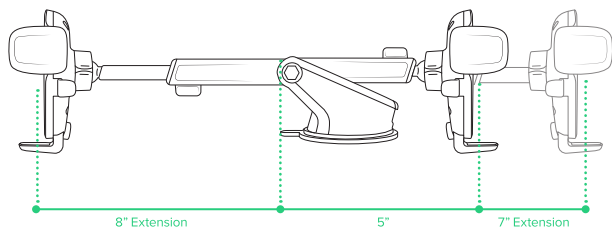

At a Glance

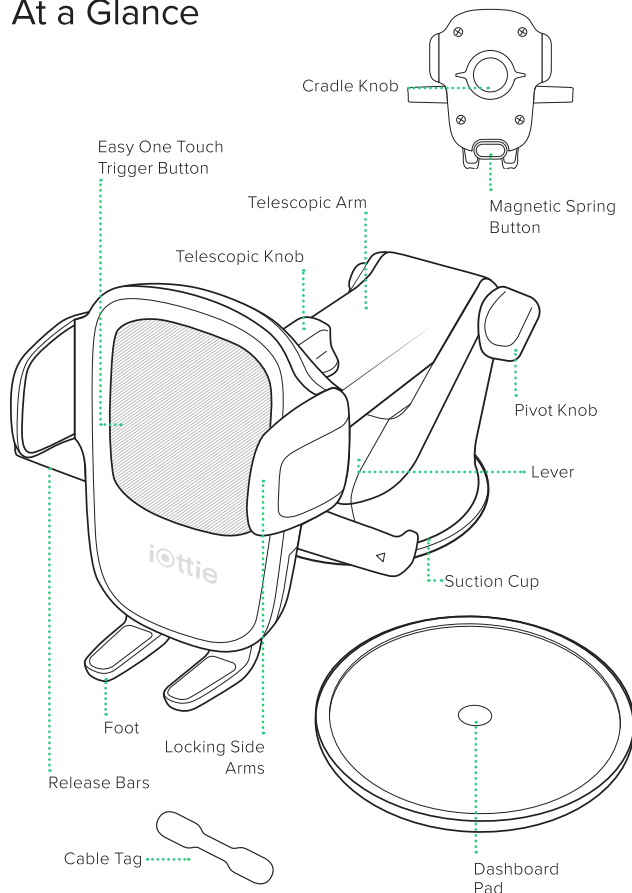

Installation

1. Assembling the Mount

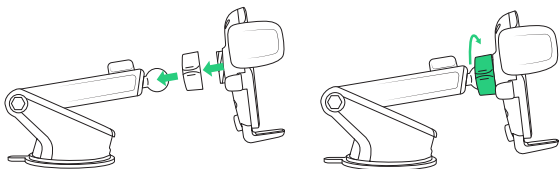

A. Connect the Mount Cradle with the Ball Joint.

B. Then, tighten the Cradle Knob.

2. Selecting a Location

Choose an installation method: Dashboard/Flat Surface (A) or Windshield/Curved Glass (B).

Option A

Dashboard or Flat Surface Installation

Choose an area on a flat surface on the vehicle's dashboard and wipe any dust or debris from the surface.

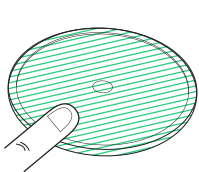

1. Peel off the film on the dashboard pad & stick on the desired installation location.



2. Peel off the protective film on the Suction Cup and press mount firmly onto the dashboard pad.

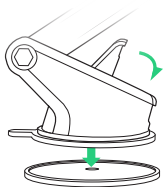

3. Push Locking Lever down to engage suction.

! When removing the dash pad please use caution, we recommend removing slowly from the edge to avoid damage.

Option B

Windshield Installation or Curved Glass Installation

Choose a location on the windshield and wipe any dust or debris from the surface.

! Not recommended to use the dashboard pad for windshield mounting.

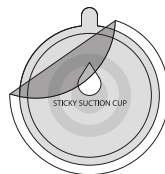

1. Peel off the protective film on the Suction Cup and press firmly onto the windshield.

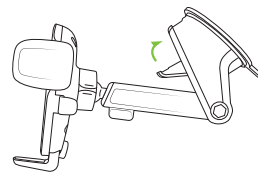

2. Push Locking Lever down to engage suction.

Additional Information

! To reuse Suction Cup, simply rinse under warm water and let air dry to restore tacky suction.

! Magnetic Cord Organizer to keep your cord organized and out of the way.

A

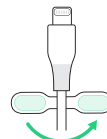

B

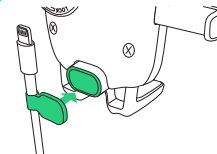

Using the Easy One Touch Mechanism

The Easy One Touch lock and release mechanism makes it simple to mount & retrieve smartphones in seconds.

Mounting

1. Press the locking side arms in.

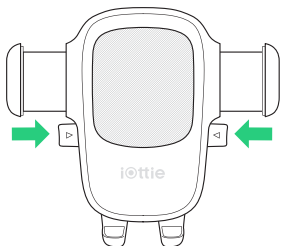

2. Press your device against the Easy One Touch trigger button. The mount's arms will automatically close on contact and hold the device during the driving journey.

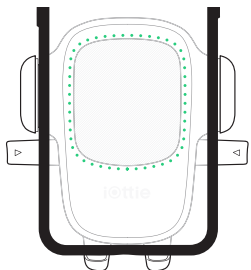

Releasing

Press the locking side arms with one hand and retrieve the device.

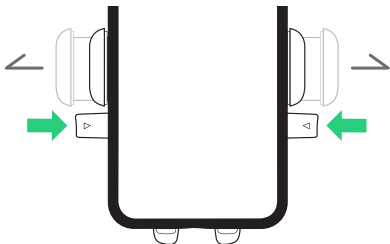

Adjusting the Mount



1. Cradle Knob

When mounting in landscape mode, loosen to rotate the Cradle. Tighten to lock in desired position.

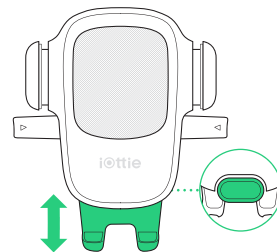

2. Foot Button

Located at the back of Cradle. Push the button to re-position mounts foot. The Foot can be adjusted up and down to fit any size phone.

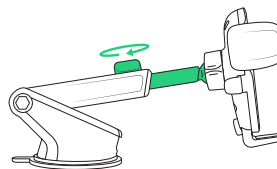

3. Telescopic Knob

Located on top of Telescopic Arm, loosen to extend the arm, and tighten to secure distance.

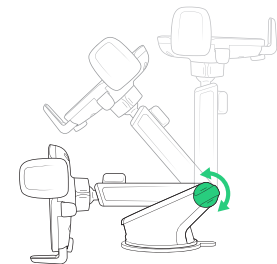

4. Pivot Knob

Located on the side of the Mount Base, turning allows you to pivot telescopic arm. Tighten to secure position.

Commencer

Pour un montage optimal, veuillez suivre les instructions détaillées de ce manuel lorsque vous utilisez l'Easy one Touch 4. iOttie n'est pas responsable des dommages éventuels causés par une mauvaise utilisation du produit.

Information cruciales

- La plaquette de tableau de bord est montée sur un ruban adhésif semi permanent. Chaque plaquette est à usage unique. Une fois retirée, elle ne peut être remise.
- Avant de fixer le produit, nous recommandons que la surface et le produit soient au-dessus de 40°F.

Spécifications

OBJET	SPECIFICATIONS
LONGEUR	16.5 cm
LARGEUR	10.7 cm
HAUTEUR	10.2 cm
POIDS	204 g

! Le bras télescopique se déploie de 13 à 20 cm

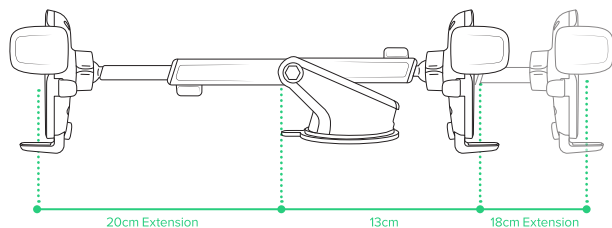

Aperçu

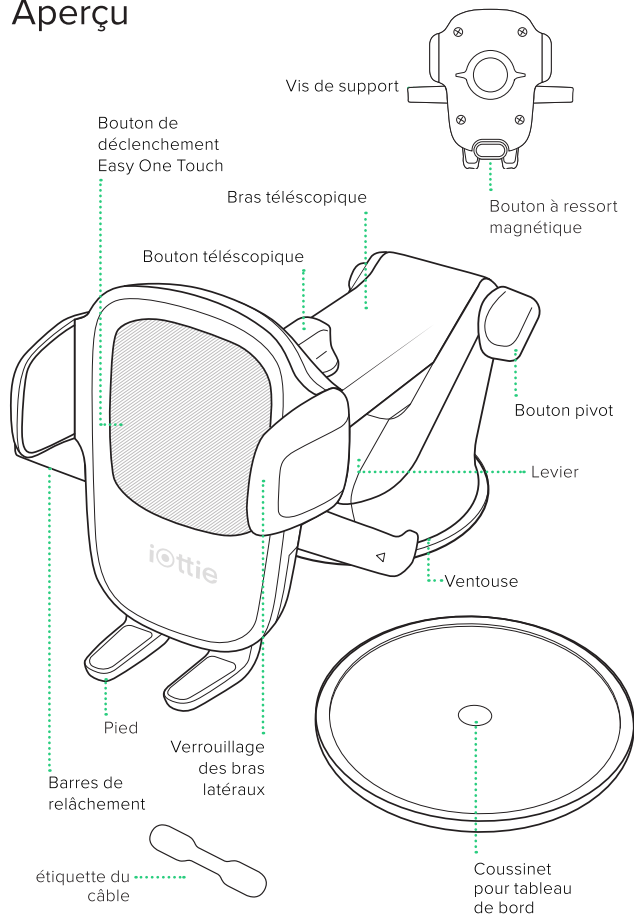

Installation

1. Assemblage du montage

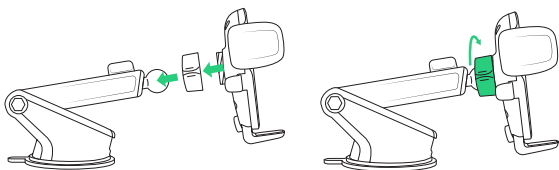

A. Connectez le support de montage avec la rotule d'attelage.

B. Serrez ensuite le bouton du support.

2. Sélection d'un emplacement

Choisissez une méthode d'installation : tableau de bord/surface plane (A) ou pare-brise/verre incurvé (B).

Option A

Installation sur tableau de bord ou sur surface plane

Choisissez une zone sur une surface plane du tableau de bord du véhicule et éliminez toute poussière ou débris de la surface.

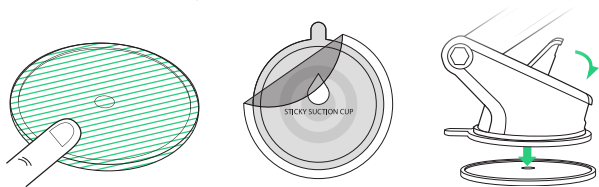

1. Retirez le film du tableau de bord puis collez-le sur le lieu d'installation désiré.

2. Retirez le film protecteur de la ventouse puis appuyez-la fermement sur la surface plane du tableau de bord.

3. Enclenchez le levier de verrouillage vers le bas pour mettre en œuvre la succion.

! Lorsque vous retirez le tableau de bord, faites attention, nous vous recommandons de le retirer lentement à partir du bord pour éviter tout dommage.

Option B

Installation sur pare-brise ou installation sur verre incurvé

Choisissez un emplacement sur le pare-brise et éliminez toute poussière ou débris de la surface.

! Il n'est pas recommandé d'utiliser le disque du tableau de bord pour le montage au pare-brise.

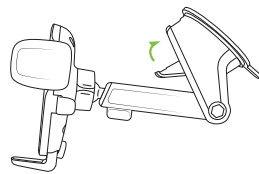
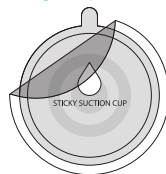

1. Retirez le film protecteur de la ventouse puis appuyez-la fermement sur la surface plane du le pare-brise.

2. Enclenchez le levier de verrouillage vers le bas pour mettre en œuvre la succion.

Informations supplémentaires

! Pour réutiliser la ventouse, rincez-la simplement à l'eau chaude et laissez-la sécher à l'air afin de rétablir l'aspiration.

! Organisateur de câble magnétique pour garder votre câble de façon organisée et à l'écart.

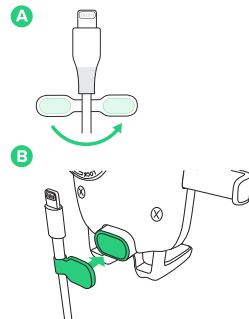

Utilisation du mécanisme Easy One Touch

Le mécanisme de verrouillage et de dégageur Easy One Touch facilite le montage et le retrait rapide des smartphones.

Montage

1. Appuyez sur les bras de verrouillage latéraux.

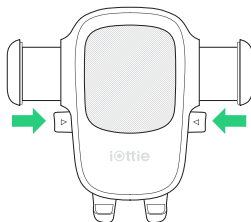

2. Appuyez votre appareil contre le bouton d'enclenchement Easy One Touch. Les bras de montage se fermeront automatiquement au contact et maintiendront l'appareil au cours de la conduite.

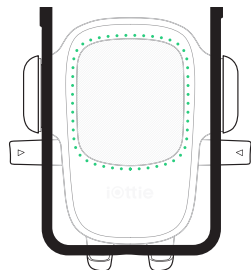

Libération

Appuyez sur les bras de verrouillages latéraux avec une main et récupérez l'appareil.

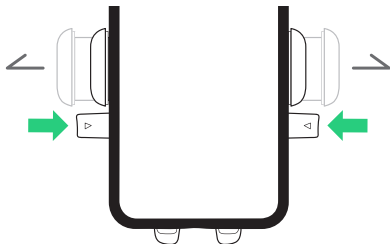

Ajustement de l'assemblage



1. Vis de support

Lors du montage en mode paysage, relâchez pour faire pivoter le support. Resserrer pour verrouiller dans la position désirée.

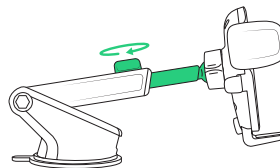

3. Bouton télescopique

Localisé en haut du bras télescopique, relâcher pour étendre le bras, et resserrer pour sécuriser la longueur.

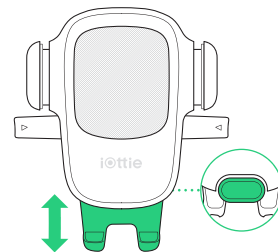

2. Bouton de pied

Situé à l'arrière du Support. Appuyez sur le bouton pour repositionner le pied du support. Le pied peut être ajusté de haut en bas pour s'adapter à n'importe quel téléphone.

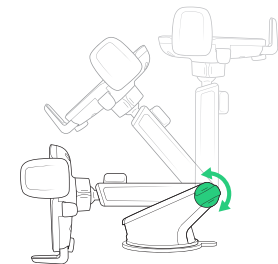

4. Bouton pivot

Localisé sur le côté de la base de support, tourner vous permet de pivoter le bras télescopique. Resserrer pour sécuriser la position.

Iniziamo

Per un montaggio ottimale, si prega di seguire le istruzioni dettagliate all'interno di questo manuale quando si usa il Easy One Touch 5.

Informazioni cruciali

- Il pannello del cruscotto è montato con un nastro adesivo semipermanente. Ogni pad è di utilizzare una sola volta. Una volta rimosso, non può essere rimontato.
- Prima di montare il prodotto, si consiglia di utilizzare la superficie e il prodotto al di sopra dei 40 °F.

Specifiche

OGGETTO	SPECIFICAZIONI
LUNGHEZZA	16.5 cm
LARGHEZZA	10.7 cm
ALTEZZA	10.2 cm
PESO	204 g

! Il braccio telescopico si estende da 13cm a 20cm.

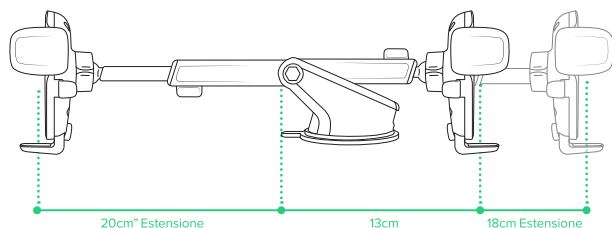

A prima vista

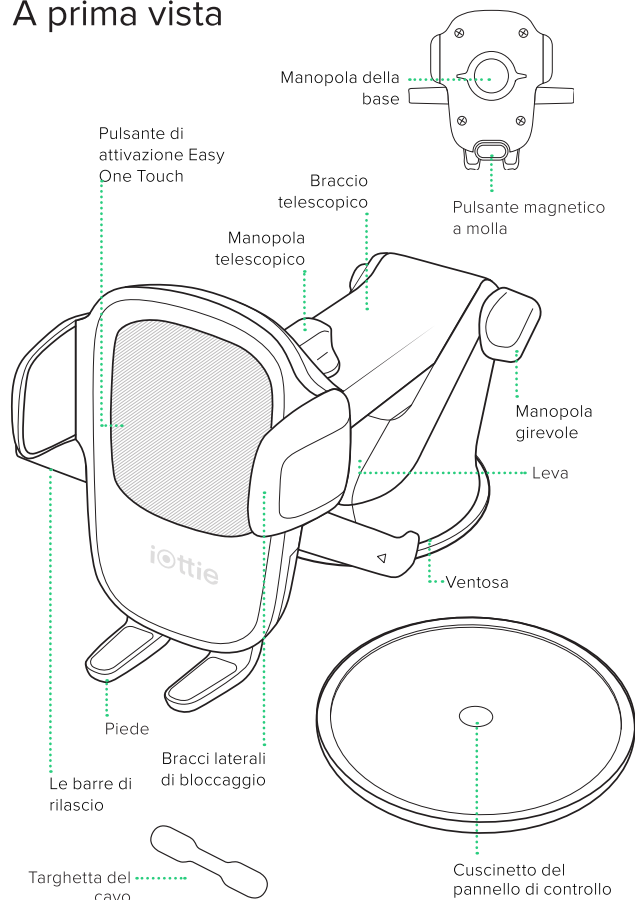

Installation

1. Il montaggio del supporto

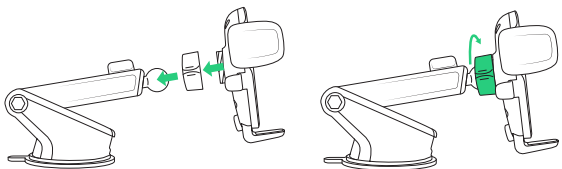

A. Collegare la base del supporto con il giunto sferico.

B. Poi, stringere la manopola della base.

2. La scelta d'una posizione

Scegliere un metodo di installazione: Cruscotto/superficie piana (A) o parabrezza/vetro curvo (B).

Opzione A

Installazione su cruscotto/superficie piana

Scegliere un'area su una superficie piana sul cruscotto del veicolo e asciugare la polvere o i detriti dalla superficie.

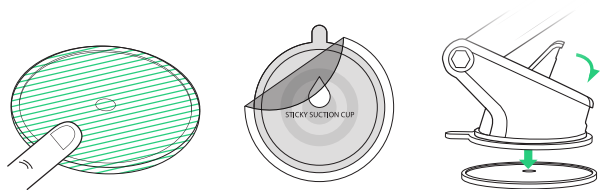

1. Staccare il film sul cruscotto e attaccarlo sul luogo di installazione desiderato.

2. Staccare la pellicola protettiva sulla ventosa e premere saldamente il supporto sul cruscotto.

3. Premere la leva di bloccaggio verso il basso per attivare l'aspirazione.

! Si prega di fare attenzione durante la rimozione del tappetino per cruscotto, si consiglia di rimuoverlo lentamente dal bordo per evitare danni.

Opzione B

L'installazione sul parabrezza o vetro curvo

Scegliere una posizione sul parabrezza e asciugare la polvere o i detriti dalla superficie.

! Si sconsiglia l'uso del tappetino per cruscotto durante il montaggio sul parabrezza.

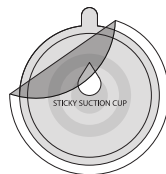

1. Staccare la pellicola protettiva sulla ventosa e premere saldamente il supporto sul parabrezza.

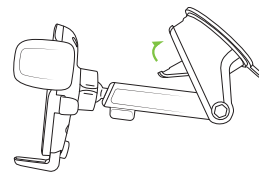

2. Premere la leva di bloccaggio verso il basso per attivare l'aspirazione.

Ulteriori informazioni

! Per riutilizzare la ventosa, semplicemente sciacquare sotto l'acqua calda e lasciare asciugare all'aria per rendere la ventosa nuovamente appiccicosa.

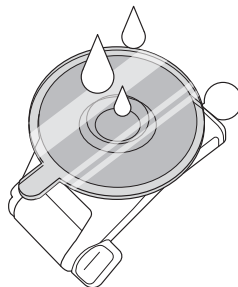

! Organizzatore di cavi magnetici per mantenere il cavo organizzato e fuori mano.

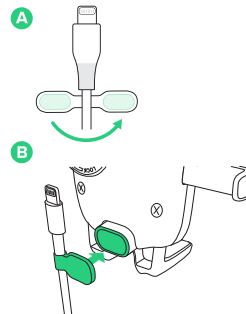

Utilizzo del meccanismo Easy One Touch

Il meccanismo di blocco e rilascio Easy One Touch semplifica il montaggio e il recupero degli smartphone in pochi secondi.

Il montaggio

1. Premere i bracci laterali di bloccaggio.

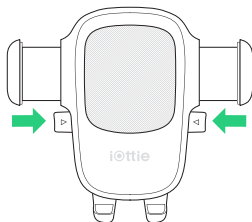

2. Premere il dispositivo contro il pulsante di attivazione Easy One Touch. I bracci del supporto chiuderanno automaticamente al contatto e terranno il dispositivo durante il viaggio.

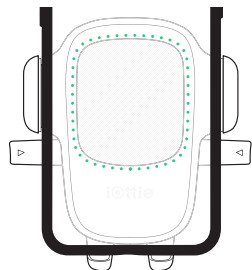

Il Rilascio

Premere i bracci laterali di bloccaggio con una mano e recuperare il dispositivo.

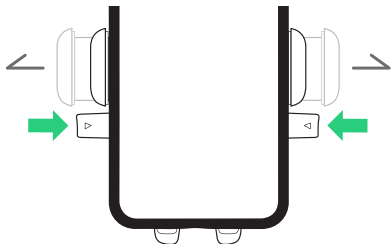

Regolazione del Supporto



1. Manopola della base

Per montare in modalità orizzontale, allentare per ruotare la base. Stringere per bloccare nella posizione desiderata.

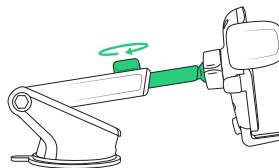

3. Manopola telescopico

Situato sulla parte superiore del braccio telescopico, allentare per estendere il braccio e stringere per allacciare la distanza.

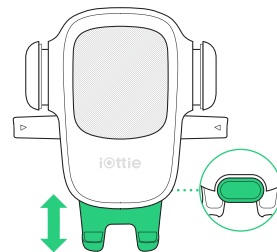

2. Pulsante a pedale

Situato sul retro del supporto. Premere il pulsante per riposizionare i supporti del pedale. Il pedale può essere regolato in alto e in basso per adattarsi a tutte le dimensioni del telefono.

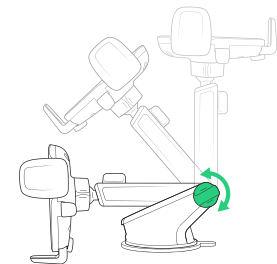

4. Manopola girevole

Situato sul lato della base del supporto, la rotazione si lascia di ruotare il braccio telescopico. Stringere per allacciare la posizione.

Erste Schritte

Befolgen Sie für einen optimalen Einbau die detaillierten Anweisungen in diesem Handbuch, wenn Sie das Easy One Touch 5 verwenden.

Kritische Information

- Das Armaturenblett-Pad ist mit einem semipermanenten Klebeband befestigt. Jedes Pad wird nur einmal verwendet. Einmal entfernt, kann es nicht wieder montiert werden.
- Wir empfehlen, dass die Oberfläche eine Temperatur von über 40 °F aufweist, bevor Sie das Produkt befestigen.

Specifications

ARTIKEL	SPEZIFIKATIONEN
TIEFE	16.5 cm
BREITE	10.7 cm
HÖHE	10.2 cm
GEWICHT	204 g

! Der Teleskoparm erstreckt sich von 13cm bis 20cm.

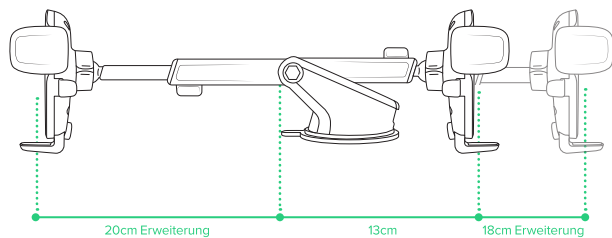

Auf einen Blick

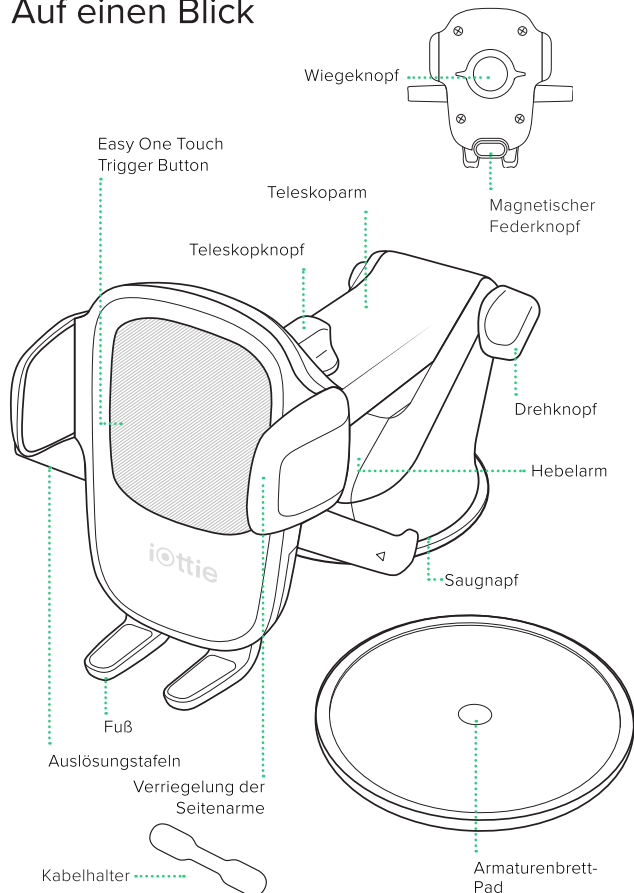

Installation

1. Montage der Halterung

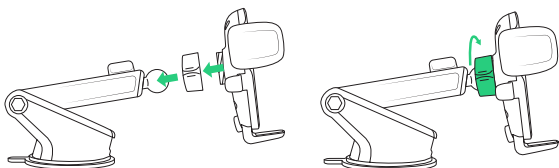

A. Verbinden Sie die Montagehalterung mit dem Kugelgelenk.

B. Dann ziehen Sie den Wiegeknopf fest.

2. Auswahl des Ortes

Wählen Sie eine Installationsmethode: Armaturenbrett / flache Oberfläche (A) oder Windschutzscheibe / gebogenes Glas (B).

Option A

Installation von Armaturenbrett oder flacher Oberfläche

Wählen Sie einen Bereich auf einer flachen Oberfläche auf dem Armaturenbrett des Fahrzeugs und wischen Sie Staub oder Schmutz von der Oberfläche ab.

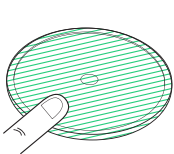

1. Ziehen Sie den Film vom Armaturenbrett-Pad ab und kleben Sie den gewünschten Installationsort fest.

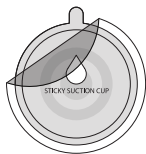

2. Ziehen Sie den Schutzfilm vom Saugnapf ab und kleben Sie die Halterung fest auf das Armaturenbrett-Pad.



3. Drücken Sie den Verriegelungshebel nach unten, um die Absaugung zu aktivieren.

! Beim Entfernen der Armaturenbrett-Unterlage ist Vorsicht geboten. Wir empfehlen ein langsames Entfernen vom Rand aus, um Schäden zu vermeiden.

Option B

Windschutzscheibeninstallation oder gebogene Glasinstallation

Wählen Sie einen Ort an der Windschutzscheibe und wischen Sie Staub oder Schmutz von der Oberfläche ab.

! Ein Verwenden der Armaturenbrett-Unterlage auf der Windschutzscheibe wird nicht empfohlen.



1. Ziehen Sie den Schutzfilm vom Saugnapf ab und drücken Sie die Halterung fest auf die Windschutzscheibe.

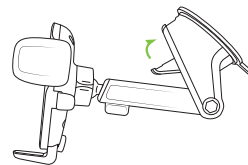

2. Drücken Sie den Verriegelungshebel nach unten, um die Absaugung zu aktivieren.

Zusatzinformationen

! Um den Saugnapf wiederzuverwenden, spülen Sie ihn einfach unter warmem Wasser ab und lassen Sie ihn an der Luft trocknen, um die haftende Saugfähigkeit wiederherzustellen.

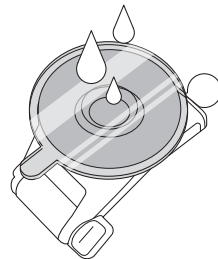

! Magnetischer Kabelhalter, damit das Kabel organisiert und nicht im Weg ist.

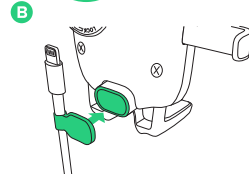
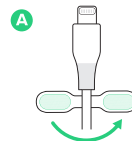

Verwenden von Easy-One-Touch-Mechanismus

Mit dem Easy-One-Touch-Verriegelungs- und Freigabemechanismus können Sie Ihr Smartphone in Sekundenschnelle montieren und abholen.

Einbau

1. Drücken Sie die Verriegelungsseitenarme ein.

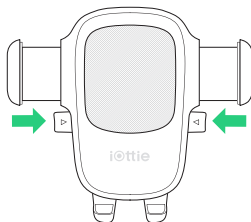

2. Drücken Sie Ihr Gerät gegen die Easy-One-Touch-Auslösetaste. Die Arme der Halterung schließen sich bei Berührung automatisch und halten das Gerät während der Fahrt.

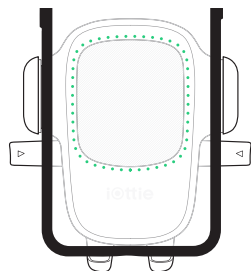

Freigabe

Drücken Sie die Verriegelungsseitenarme mit einer Hand und holen Sie das Gerät ab.

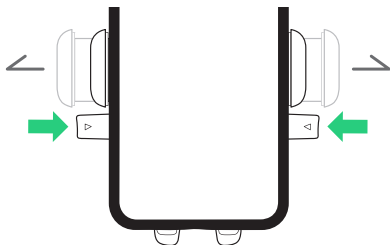

Einstellung der Halterung



1. Wiegeknopf

Wenn Sie im Querformat montieren, lösen Sie die Wiege, um sie zu drehen. Ziehen Sie sie fest, um die gewünschte Position festzulegen.

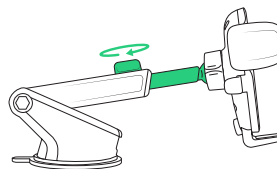

3. Teleskopknopf

Sich auf dem Teleskoparm befindend, lockern Sie den Arm und ziehen Sie ihn fest, um den Abstand zu sichern.

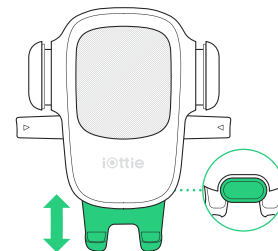

2. Fuß-Taste

Befindet sich auf der Rückseite der Halterung. Drücken Sie den Knopf, um den Fuß der Halterung neu zu positionieren. Der Fuß kann nach oben und unten verstellt werden, damit er für jede Telefongröße passt.

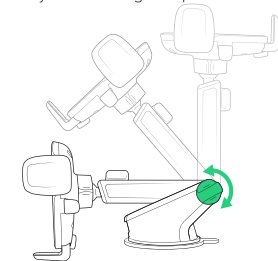

4. Drehknopf

An der Seite der Montagesockel gelegen, durch Drehen können Sie den Teleskoparm schwenken. Ziehen Sie in fester Position fest.

Empezando

Para conseguir un fijación ideal, siga atentamente las instrucciones que se incluyen en este manual al usar el Easy One Touch 5. iOttie no es responsable por posibles daños debidos al uso incorrecto del producto.

Información crucial

- La almohadilla para el tablero de instrumentos se fija con una cinta adhesiva semipermanente. Cada almohadilla se usa una sola vez. Una vez retirada, no se puede volver a colocar.
- Antes de montar el producto, recomendamos que la superficie y el producto estén por encima de los 40°F.

Specifications

ARTICULO	ESPECIFICACIONES
PROFUNDIDAD	16.5 cm
ANCHO	10.7 cm
ALTURA	10.2 cm
PESO	204 g

! El brazo retráctil se extiende de 13 a 20 cm.

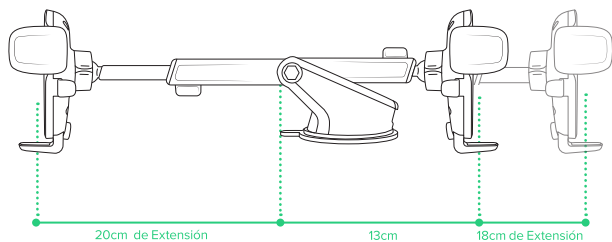

De un vistazo

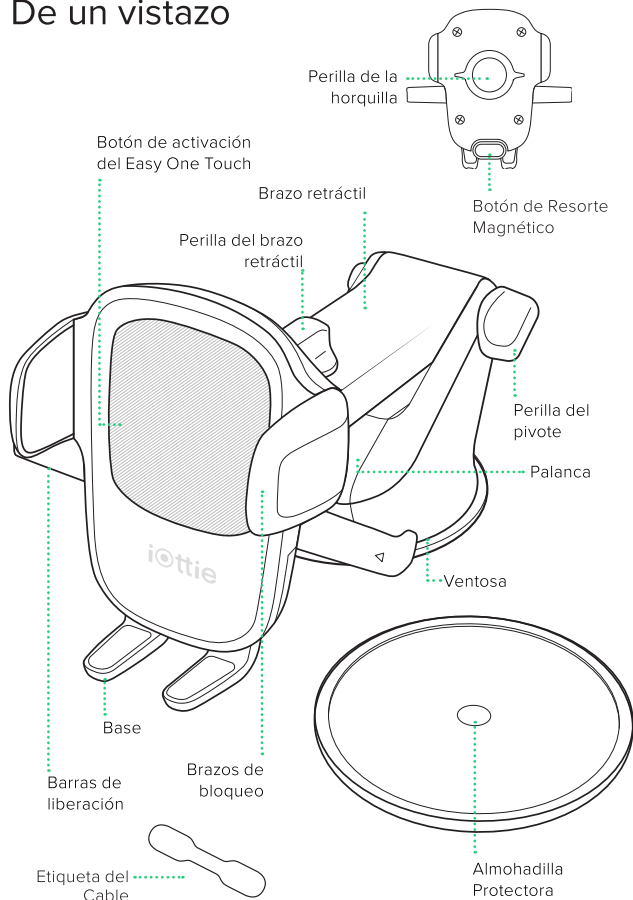

Instalación

1. Colocación del soporte

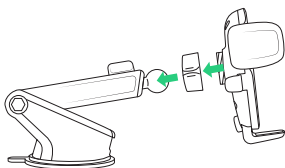

A. Conecte la horquilla a la junta esférica.

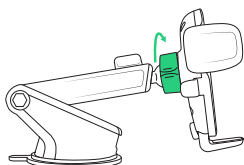

B. Luego, apriete la perilla de la horquilla.

2. Elija un lugar

Elija un método de instalación: Tablero de instrumentos/superficie plana (A) o parabrisas/vidrio curvado (B).

Opción A

Instalación en el tablero o en una superficie plana.

Elija un área en una superficie plana en el tablero del vehículo y limpie todo el polvo o residuos de la misma.

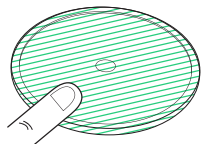

1. Quite el papel protector de la almohadilla del tablero y péguela en el lugar que desee.



2. Quite el papel protector de la ventosa y presione firmemente el soporte sobre la almohadilla del tablero.

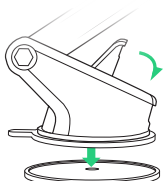

3. Presione hacia abajo la palanca de bloqueo para activar la succión.

! Tenga cuidado al retirar la almohadilla protectora. Recomendamos retirarla lentamente desde el borde para evitar daños.

Opción B

Instalación en parabrisas o vidrio curvo

Elija un lugar en el parabrisas y limpie el polvo o residuos de la superficie.

! No se recomienda usar la almohadilla protectora para el montaje del parabrisa.

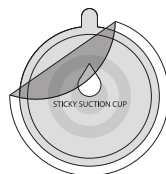

1. Quite el papel protector de la ventosa y presione firmemente el soporte sobre el parabrisas.

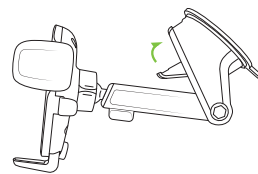

2. Presione hacia abajo la palanca de bloqueo para activar la succión.

Información adicional

! Para reutilizar la ventosa, simplemente enjuague con agua tibia y deje que se seque al aire para restaurar la succión pegajosa.

! Organizador de cable magnético mantiene los cables organizados.

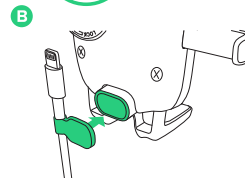

Uso del mecanismo Easy One Touch

El mecanismo de bloqueo y desenganche Easy One Touch hace que sea fácil colocar y retirar teléfonos inteligentes en cuestión de segundos.

Colocación

1. Presione los brazos de bloqueo.

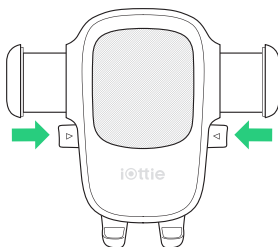

2. Presione su dispositivo contra el botón de activación del Easy One Touch. Los brazos de la montura se cerrarán automáticamente al entrar en contacto y sujetarán el dispositivo durante el viaje.

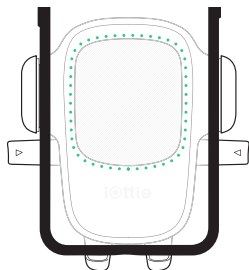

Retirar

Presione los brazos de bloqueo con una mano y retire el dispositivo.

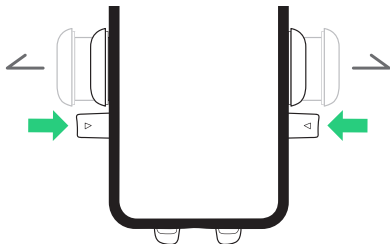

Ajuste del soporte



1. Perilla de la horquilla

Cuando lo instale en modo horizontal, afloje la perilla para girar la horquilla. Apriétela para fijarla en la posición deseada.

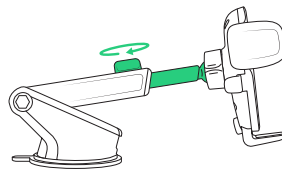

3. Perilla del brazo retráctil

Use la perilla ubicada en la parte superior del brazo extensible, aflojéla para extender el brazo y apriétela para fijar su longitud.

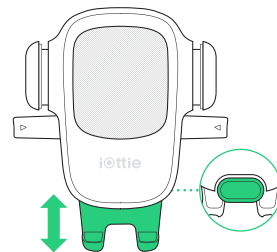

2. Botón de liberación del pie

Ubicado en la parte trasera de la montura. Presione el botón para volver a colocar el pie de montaje.

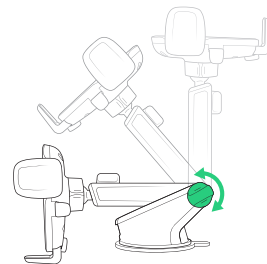

4. Perilla del pivote

Use la perilla ubicada en un lado de la base del soporte, al aflojarla se puede mover el brazo extensible. Apriétela para fijar la posición.



EN If you love your iOttie product, let us know by leaving a review online, or connect with us on our social platforms.

FR Si vous aimez votre produit iOttie, merci de nous le faire savoir en laissant un commentaire en ligne ou nous rejoindre sur nos réseaux sociaux.

IT Se ami il tuo prodotto iOttie, faccelo sapere lasciando una recensione online o sulle nostre piattaforme social.

DE Wenn Sie von Ihrem iOttie-Produkt begeistert sind, lassen Sie es uns bitte wissen, indem Sie eine Bewertung online abgeben oder sich mit uns auf unseren sozialen Plattformen verbinden.

ES Si le gusta su producto iOttie, háganos saber dejando una reseña en línea, o conéctese con nosotros en nuestras plataformas sociales.

Hiermit erklärt iOttie, dass sich diese in Übereinstimmung mit den grundlegenden Anforderungen und den übrigen einschlägigen Bestimmungen der Richtlinie 2014/53/EU befindet. Die EG-Konformitätserklärung kann hier heruntergeladen werden: <https://www.iottie.com/support/doc>

iottie



20 W 37th St
New York, NY 10018
U.S.A.

 www.iottie.com

 cs@iottie.com